

FLOOR SYSTEM



for Opel Movano L3
Renault Master L3



- ◆ flexible floor system to make a wheelchair bus
- ◆ up to 4 wheelchair passengers or 8 passengers



B|STYLE

MOBILITY SOLUTIONS



Secure a wheelchair passenger

There are 5 belt pop-ups per wheelchair space, which can be completely covered with a lid. In 4 of these belt pop-ups there are safety belts with a hook and lamp, meant to secure a wheelchair and keep it in place during a journey. The adjustable seatbelt column is used to secure the wheelchair passenger. The buckle for that last belt is in the fifth belt pop-up in the floor.



Touch-screen control - Safe and easy

For daily, intensive use, you want an easy-to-operate system. This is provided by a touch-screen that allows you to operate the disability car. The touch-screen is placed at the driver's side, where he/she activates the process for the correct wheelchair position. This opens the front two belt pop-ups and extends and illuminates the hooks so they are clearly visible, even in the dark.



Great visibility and flexibility

The wheelchair passenger always has good visibility through the windows, because the tip-and-turn seats are the only seats in their class to be folded down under the windows. When there is no wheelchair passenger in the wheelchair space, the tip-and-turn seats can be folded down for other passengers.



Safe passenger transport

If the belt pop-ups that are integrated in the B-FIT floor are not used, they are automatically covered by a lid. This creates a completely flat floor on which passengers are less likely to stumble in the passenger bus.



Boarding and alighting

Wheelchair passengers enter the wheelchair van via a wheelchair lift attached to the B-FIT floor at the rear. You decide for yourself what type of lift you want to install, there is a pre-drilled hole pattern in the floor. The other passengers can enter via the sliding door on the side of the bus.



Personalizing your Sprinter Wheelchair Bus

You decide how many tip-and-turn seats you want. You can also choose a panel in the headliner with ambient lighting, a safety hammer ventilation and space for extra speakers.



B|STYLE

CREATE A BIGGER WORLD

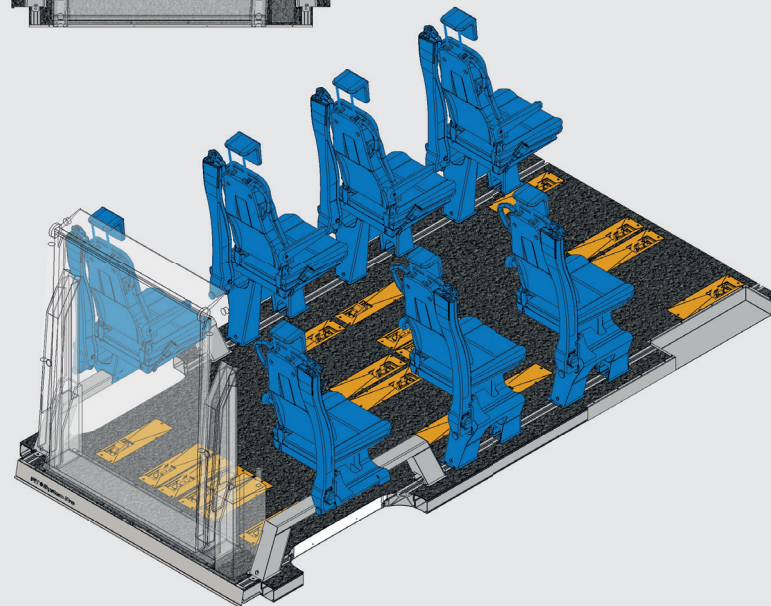
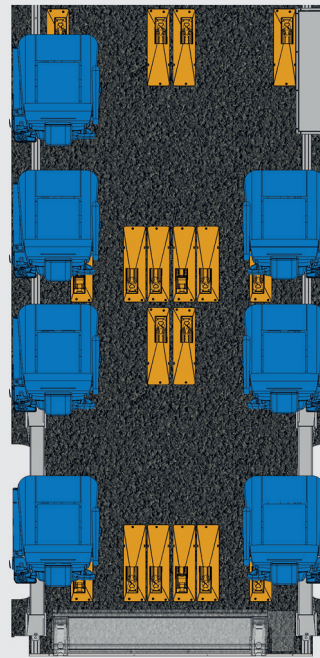
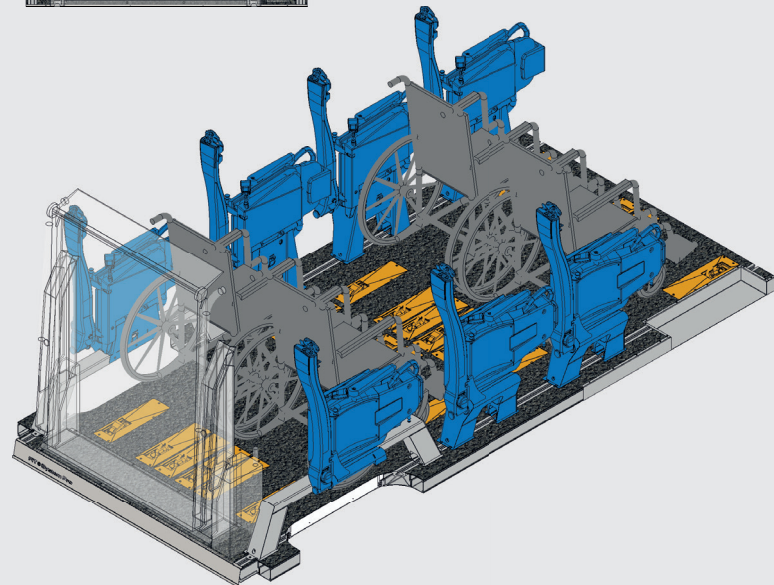
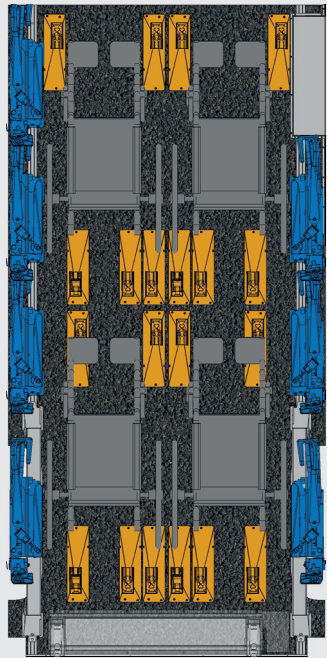

Configuration options

With the B-FiT floor system the number of (wheelchair) passengers you can carry is flexible. If you do not use a wheelchair position, you can use two tip-and-turn seats instead. There are many configurations to choose from, depending on your Sprinter and wishes.



B|STYLE

CREATE A BIGGER WORLD

B|FIT FLOOR SYSTEM FOR OPEL MOVANO AND RENAULT MASTER L3



Number of tip-and-turn seats is flexible



Built-in quickly



No welding required



Step-by-step installation manual



Available for 2 lengths (L2, L3 and L4)



High Quality Floor System









Wheelchair lift of your choosing, pre-drilled hole pattern in floor



Great visibility, seats are folded below the windows



All test reports available



B-style

+31 418 638200
info@b-style.eu

Take a look at our other products at b-style.eu.



B|STYLE

CREATE A BIGGER WORLD